

MAKELSAN®
Kesintisiz Güç Kaynakları

OPERATING MANUAL
MRGMSR SERIES
SERVO VOLTAGE REGULATOR
120-150 Kva
(GM-SD-49)

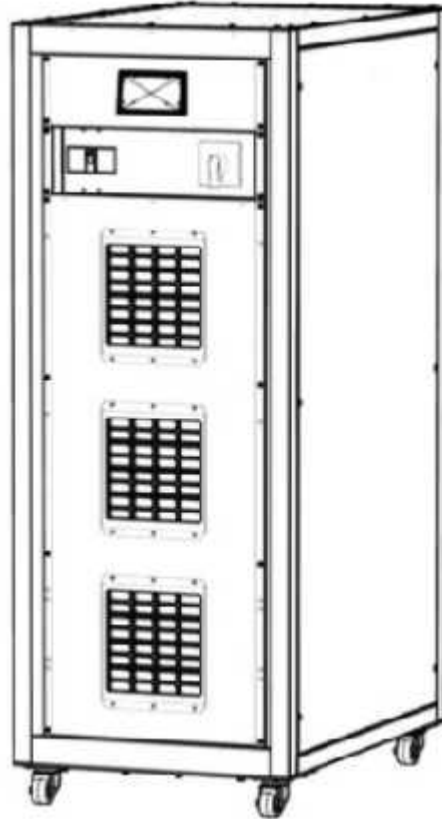

OPERATING MANUAL
MRGMSR SERIES
SERVO VOLTAGE REGULATOR
120-150 Kva
(GM-SD-49)

About Manual

This manual, had been prepared for the users of MRG/MSR33 Series 120-150 kVA Servo Voltage Regulator.

Subsidiary Manuals

Please visit the web address of www.makelsan.com.tr for further information about this device and its options.

Updates

Please visit the web address of www.makelsan.com.tr for the updates. Always use updated manuals.

Transport

The hauling vehicle or its handhold must have the characteristic and sufficiency that is able to haul the weight of regulator.



DO NOT LIFT HEAVY LOADS WITHOUT HELP!



<18 kg (<40 lb)



32-55 kg (70-120 lb)



18-32 kg (40-70 lb)



>55 kg (>120 lb)



TABLE OF CONTENTS

Transport.....	i
1 SAFETY AND WARNINGS.....	1
1.1 Warnings.....	1
1.2 Spaces and Access	2
1.3 Storage	2
1.4 Transport.....	2
2 PRODUCT OVERVIEW	3
2.1 General Information.....	5
2.2 Operating Modes of the Regulator.....	6
2.2.1 Normal Mode	6
2.2.2 Mechanical Bypass Mode.....	6
2.2 User Panel.....	6
2.4.1 Splash Screen.....	7
2.4.2 Status Menu.....	10
2.4.3 Alarm Menu.....	10
2.4.4 Service Menu.....	11
3 INSTALLATION.....	12
3.1 Warnings	12
3.2 Initial Control Before Startup	13
3.3 Positioning the Device	13
3.4 Mode of Transport of the Cabins.....	13
3.5MRG/MSR33 Series Servo Voltage Regulator Recommended Connection Type	14
3.5.1 External Guards	14
3.5.2 Cable Selection	14
3.5.3 Connection of the Cables.....	15
4 OPERATION	16
4.1 Operation Procedure.....	16
4.1.1 Circuit Breakers.....	16
4.1.2 Startup.....	17
4.1.3 Passing to Mechanical Bypass Mode.....	18
4.1.4 Fully Shutting Down the Regulator	18
5 WARNINGS and THEIR EXPLANATIONS.....	19
6 TABLE OF TECHNICAL SPECIFICATIONS	20

7 WARRANTY 21

7.1 Terms of Warranty..... 21

7.2 The Situations not Covered by the Guarantee 22

8 CONTACT INFORMATION..... 24

1 SAFETY AND WARNINGS

1.1 Warnings

This device may be used by children over 8 years old and the ones who have lack of physical, sensorial or mental ability or the ones having lack of experience and knowledge if the surveillance or direction has been given to them related with its safely operating and if the dangers it includes have been understood by themselves. The children should not play with the device. Cleaning and user's maintenance should not be performed by children.

This manual must be read and understood before the installation of the regulator is made. The installation and the first initialization can be made only by authorized MAKELSAN personnel.

Making installation and initialization by unauthorized persons may cause serious injuries and/or may result in death.

The regulator has been designed as being used always vertically in fixed positioned applications.

The flammable and heat affected materials should not be kept around the device.

The environment that the device is placed must have the ideal temperature values. The regulator must not be exposed to direct sun light and its installation must not be made in humid/ moist environment.



THE REGULATOR MUST BE USED VIA THE EARTH CONNECTION.

Make the earth connection before connecting to mains.



THE INLET SWITCH MUST BE TURNED TO OFF POSITION AND MAINS/REGULATOR SELECTION SWITCH (PACCO SWITCH) MUST BE TURNED TO "0" POSITION BEFORE STARTING MAINTENANCE.

Service-maintenance

All service and maintenance operations are made within the device. The parts are subjected to maintenance and replacement only by trained personnel.



It is recommended a preventive maintenance at least once in a year beginning from the installation by authorized technical personnel. (This service shall be provided by our authorized services for a service fee.)

The fire extinguisher equipment must be placed in proximity of regulator.

1.2 Spaces and Access

Spaces

At least 100 cm of space must be left around the ventilation grilles and the ventilators in 120-150 kVA Regulators. A permanent or temporary operation must not be conducted within this indicated boundaries. Otherwise, the performance of the regulator will decrease.

1.3 Storage

The regulator must be stored in a room or region prevented from excess moisture and torridity before it is engaged. Keep the regulator in its original package.

1.4 Transport

The hauling vehicle or its handhold must have the characteristic and sufficiency that is able to haul the weight of regulator.

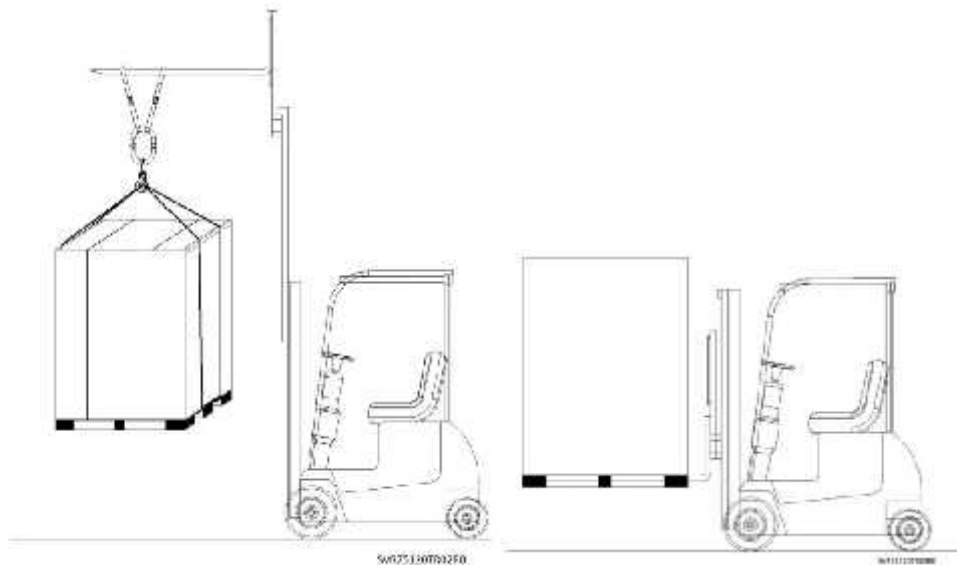

All MRG/MSR33 series servo voltage regulator cabins are delivered on transportation pallets.

Move the device as rare as possible.

2 PRODUCT OVERVIEW

Makelsan MRG/MSR33 series Servo Regulator is wide inlet voltage operating ranged, microprocessor controlled, high efficiency and high speed servo voltage regulator. It has been designed to prevent the sensitive equipment like laboratory devices, medical screening systems, communication systems, security scanners and CNC machines.

General View

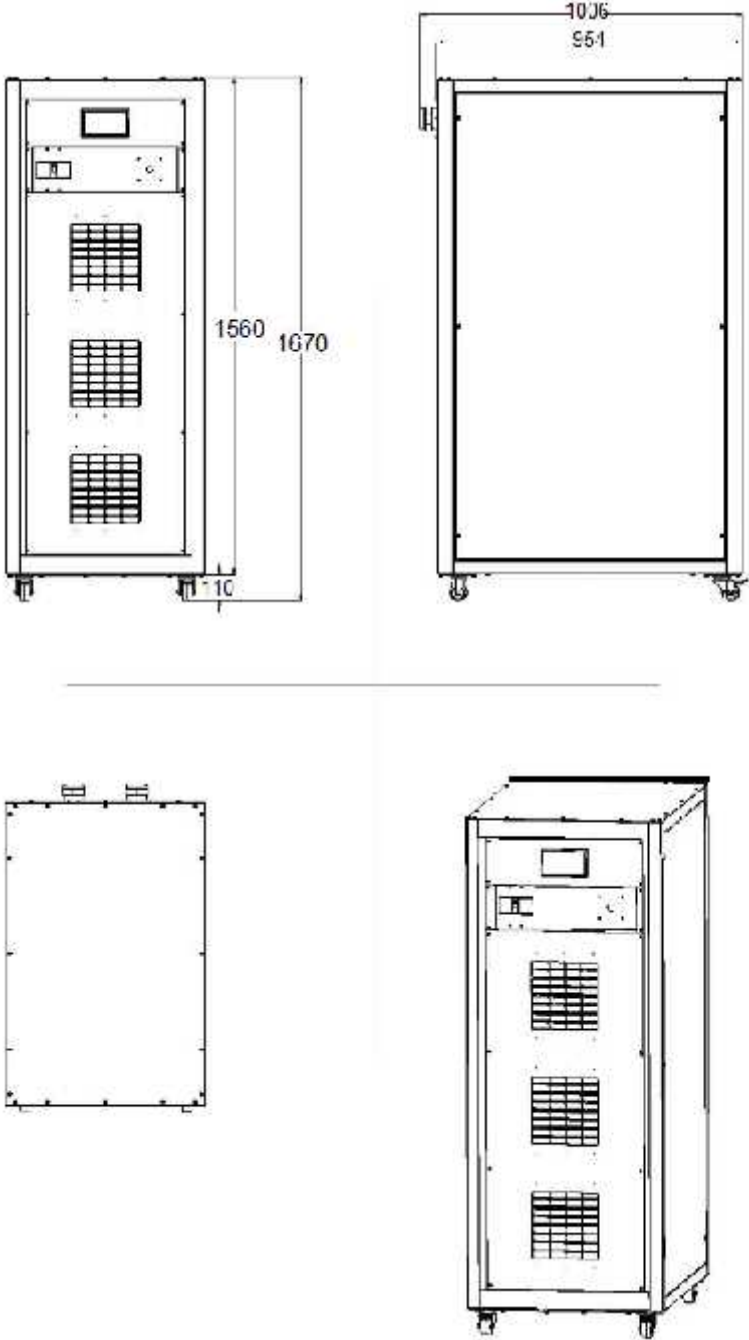

(120-150Kva)

Front View

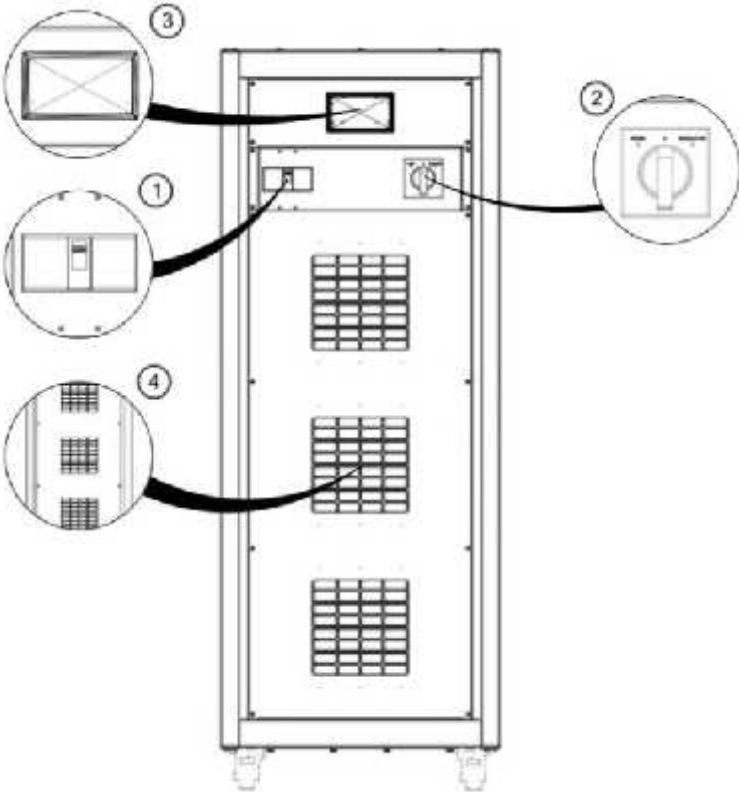

1	Inlet Fuse
2	Mains/Regulator Selection Switch
3	User Panel
4	Ventilation Grilles

Rear View

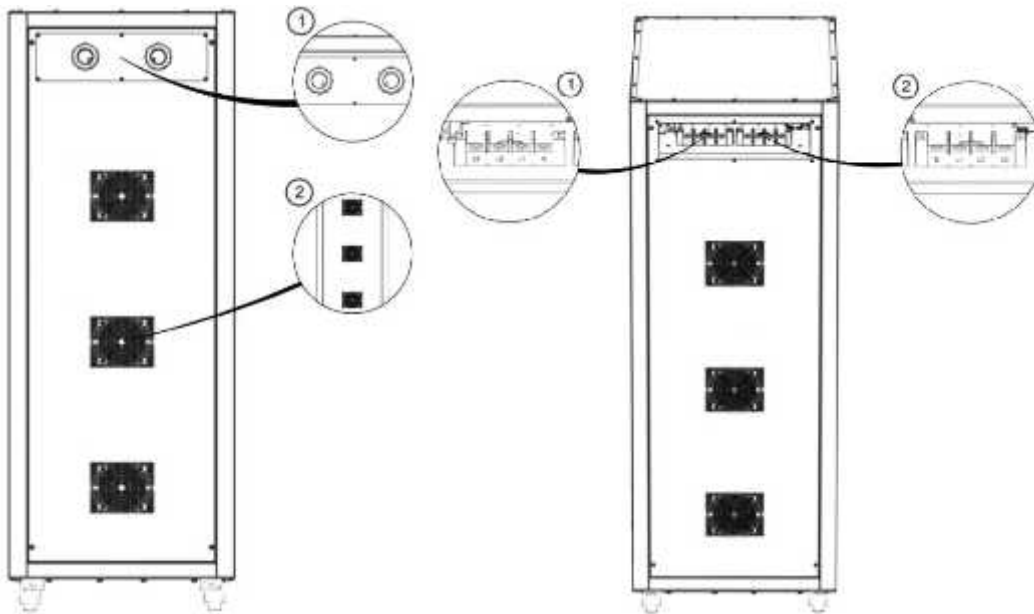

1	Inlet-Outlet Connection Terminal Cover
2	Ventilation Grilles
3	Ventilation Fan (120-150 kVA)

1	Outlet Terminal
2	Inlet Terminal

2.1 General Information

The operation topology of MRG/MSR33 series devices can be understood via the figure below.

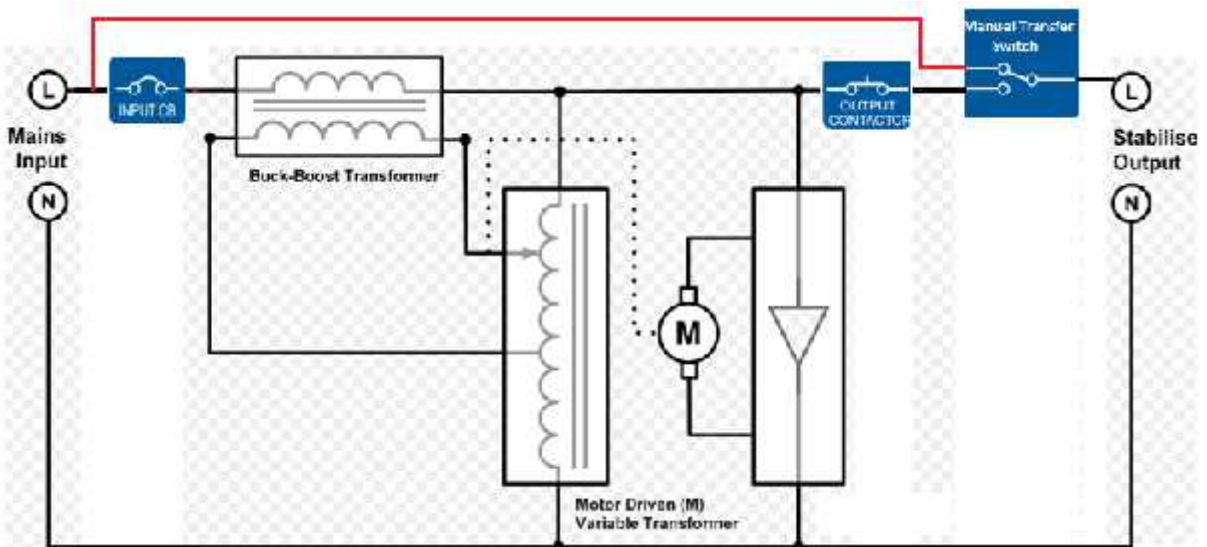

MRG/MSR33 Series Servo Voltage Regulator Boundary Diagram

MRG/MSR33 Series Servo Voltage Regulator (Servo) transfers the electric energy that it took from the mains to the outlet and consistently monitors the outlet voltage value. When a deviation occurs in the outlet voltage with respect to requested outlet voltage values, the micro controller unit provides the outlet voltage to stay in the appropriate values by instantly repositioning the variac by means of the engine.

Thus, the Servo Voltage Regulator (Servo) obtains a voltage value within the requested values at the outlet by adding (or by subtracting) the voltage value of the appropriate additional energy which it constituted via the mains electric energy to (or from) voltage value of the mains.

2.2 Operating Modes of the Regulator

The MRG/MSR33 series regulators operate in the modes below:

- Normal Mode
- Mechanical Bypass Mode

2.2.1 Normal Mode

In this mode the loads are supplied by the regulator with the regulated voltage. When the mains voltage decreases or increases, the nominal voltage is applied consistently to the loads.

2.2.2 Mechanical Bypass Mode

It can be passed to the bypass mode via the mains/regulator selection switch (pacco switch) on the front side of the regulator. In this mode, the mains energy is bypassed to the load directly for the loads not to remain out of energy during the maintenance or malfunction.

2.2 User Panel

The user panel consists of mimic diagram, LCD display, ON/OFF button and menu buttons. The device is controlled via this panel.

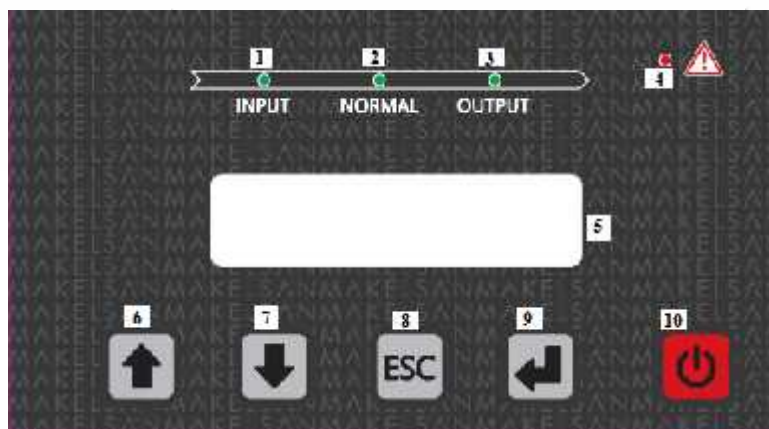

1	Inlet Led It lights when there is energy at the regulator inlet. It blinks when the mains is out of limits.
2	Normal Led It lights when the device operates normally.
3	Outlet Led It lights when the outlet voltage is within the limits and when the protection contactor is active.
4	Alarm/Warning Led It lights when there is an any warning.
5	LCD display It is displayed the device measurement information and warnings.
6 -9	Menu Buttons
10	ON/OFF Button

Menu Flow Diagram

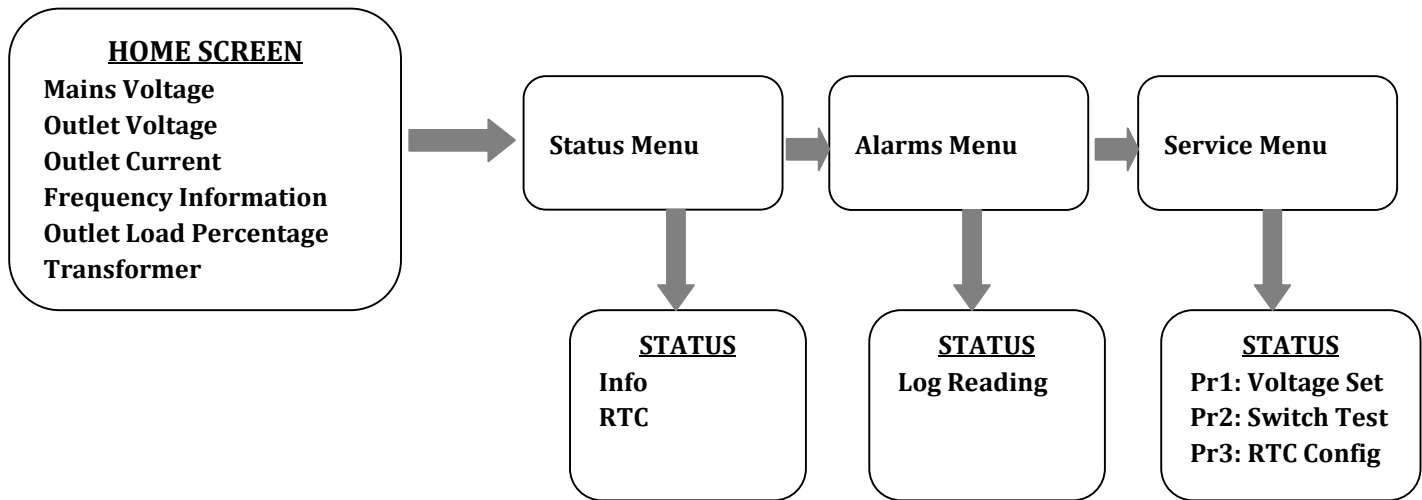

2.4.1 Splash Screen

Initially, the inlet voltage values for each phase (L1, L2, L3) are displayed when the front panel opened.

The inlet voltage values, outlet voltage values, outlet current values, frequency and, transformer temperature values can be seen respectively by using menu buttons.



) Mains Voltage (L1,L2,L3)



) Outlet Voltage (L1,L2,L3)

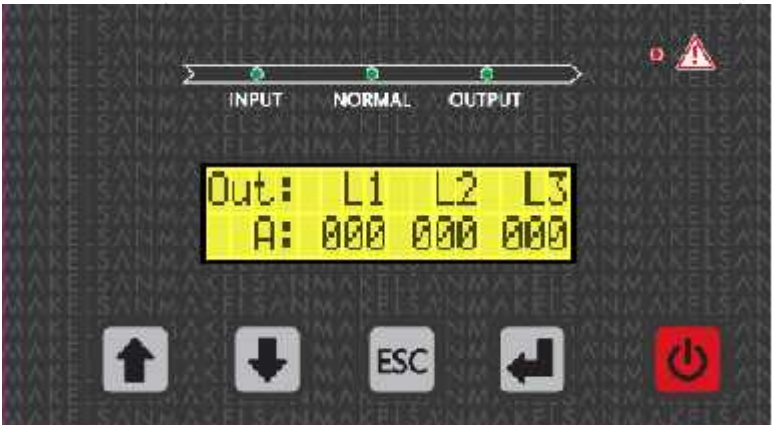

) Outlet Current Information (L1,L2,L3)



) Frequency Information (L1,L2,L3)



) % Load Information (L1,L2,L3)



) Transformer Temperature Information (L1,L2,L3)

2.4.2 Status Menu

The Device Information, Date Time information of the Regulator can be seen via this menu. It can be entered to sub menus by pressing the ENTER button after placing on the requested information via the arrows. ESC button is pressed to return to the previous menu.

-) Device Information (Info)
-) Date Time Information



) Device Information



) Date Time Information

2.4.3 Alarm Menu

The Error log record information of the Regulator can be seen via this menu. It can be entered to sub menus by pressing the ENTER button after placing on the requested information via the arrows. ESC button is pressed to return to the previous menu.



) Logging information

2.4.4 Service Menu

The Pr1: Setting the outlet voltage, Pr2: Checking the activation of Limiting Switches and, Pr3: Date time settings of the Regulator can be seen via this menu. It can be entered to sub menus by pressing the ENTER button after placing on the requested information via the arrows. ESC button is pressed to return to the previous menu.

-) Pr1:Output Voltage Set
-) Pr2:Limit switch Test
-) Pr3:RTC Config



) Pr1:Output Voltage Set



) Pr2:Limit switch Test



) Pr3:RTC Config

3 INSTALLATION

In this section, it is indicated the warnings that you should follow and the controls that you should perform before operating the device. Besides, you can find the information regarding the points to take into consideration about positioning the device, mode of transport and the connections of the cabin.

3.1 Warnings



The Regulator must be installed by the MAKELSAN confirmed personnel. Operating the regulator of which has not been installed by authorized personnel causes your device to be out of warranty coverage.

The covers of the device should not be opened by other than the authorized service personnel.



The earth connection must be placed in the mediums that the regulator operates against the electrical leakage.

The measures for preventing eyes against the electrical arcs generating from contacts must be taken.

ESD protected rubber gloves must be used.

The operator must take off the apparatus such as ring, watch, etc. that can endanger before operating.

3.2 Initial Control Before Startup

The below controls must be performed before startup of regulator device. These are the first and significant steps of correctly operating the regulator device.

- Check to see if the internal and external structure of the regulator has been damaged during hauling or transport. Please report it before receiving if there is any damage.
- Please be sure that the product is correct. Check to see if the label on the rear side of the device matches with the ordered product.

3.3 Positioning the Device

The regulator has been designed for indoor usage. Your device must be placed in the areas that are clean, that their moisture and temperature values are appropriate for the specified ranges and, that there are air flow. It must not be exposed to the direct sun light.

The flammable and heat affected materials should not be kept around (base, top, front, rear and, sides) the device. It must be positioned to the place which is far from the risk of liquid contact such as water, etc.

Water and so on liquid material must not enter inside of the device.

The clean and cool air enters from the ventilation grills of the device and exits via the fan in MRG/MSR series 120-150 kVA voltage regulator. The air inlet and outlet points must never be blocked.

3.4 Mode of Transport of the Cabins

Please be careful for the hauling vehicle or its handhold must have the characteristic and sufficiency that is able to haul the weight of the regulator.

The regulator has been designed as being able to be hauled via the forklift or suchlike vehicles.

3.5 Mains and Load Connections

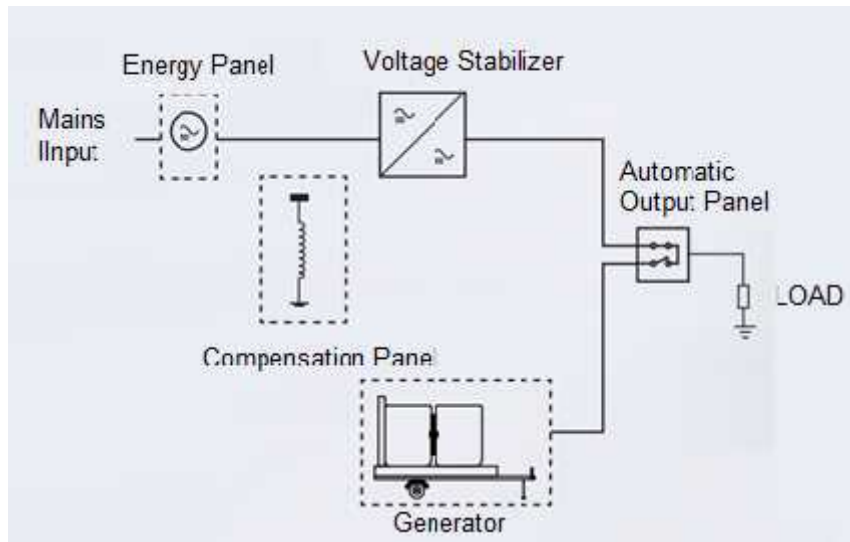

MRG/MSR33 Series Servo Voltage Regulator Recommended Connection Type

3.5.1 External Guards

The thermal magnetic switch or V-automates must be affixed to the panel individually to protect the AC inlets. The cable sections and fuse values conducted hereby must have been specified and connected by an expert person. (Please receive support from the technical service official for further information.)

There should be an over current protection in the inlet mains panel. This protection must be selected as appropriate for the bearing capacity of over current and over load of the regulator. The fuses on panel must be selected according to the 135% excess of the current values given in the table below and must be the type C (slow).

The earth leakages at the inlet and outlet of regulator flow to earth via the EMI suppress circuits. MAKELSAN hereby recommends a residual current relay over 30 mA.

The residual current relays mounted at the regulator inlet must be;
 sensitive to bidirectional DC strikes,
 insensitive to sudden pass currents,
 sensitive to average currents between 0,03-1 amperes.

3.5.2 Cable Selection

The cable characteristics must be appropriate to the hereby mentioned currents and voltages; besides, the local regulations in this subject must be taken in consideration.

Regulator Power	Inlet Cable Section	Outlet Cable Section	Earth Cable Section
120 kVA	4×70mm ²	4×50mm ²	1×95mm ²
150 kVA	4×95mm ²	4×70mm ²	1×120mm ²

NOTE: Please contact with MAKELSAN technical service for the regulator cable sections and fuse values in upper power.

Each cabin must be connected to the earth line directly and on the shortest way via the protection earth cable. It is recommended that the length of the cable should not exceed 5 meters.

3.5.3 Connection of the Cables

The connections are conducted on the rear side of the regulator.

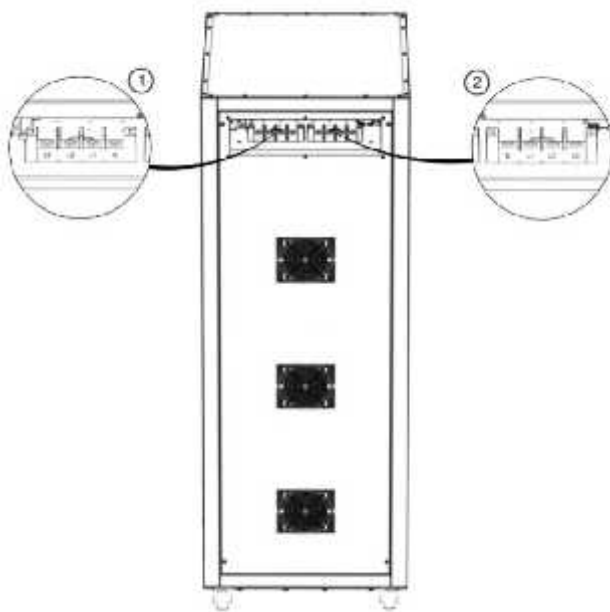

1	Outlet Connection Terminal
2	Inlet Connection Terminal

Electrical Bounding

Please follow the steps below for the electrical bounding:

1. Please be sure that the loads and mains are isolated from cables by turning all switches on the distribution panel to open circuit (OFF) position.
2. Please disassemble the connection cover for making cable connections of the regulator.
3. Connect the earth cable.
4. Please be sure that all switches on the device are at open circuit (OFF) position. The usages of the switches will be expressed in the following sections.

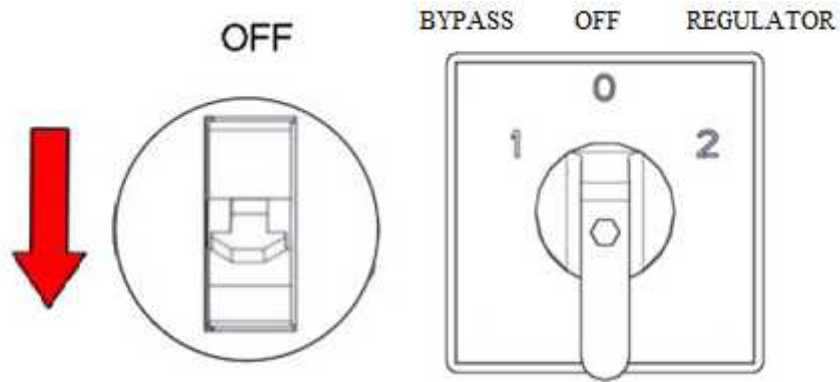

The inlet and bypass switch are at OFF position.

5. Connect inlet and outlet cables selected according to the appropriate section;

- R phase to inlet L1,
- S phase to inlet L2,
- T phase to inlet L3,
- N (neutral) to inlet N.

6. Check the phase order.

7. Repeat the 5th and the 6th steps for the outlet connections.



Please pay attention that the loads are isolated during connection if the loads on the prepared regulator outlet have not been ready to be connected yet.



Be sure that the grounding has been made correctly. The wrongful acts and grounding that has been made may damage the regulator and other systems in the installation.

4 OPERATION

4.1 Operation Procedure

You can find information about the startup and shutting down of the regulator in this section.

4.1.1 Circuit Breakers

There are 1 piece of INLET switch, 1 piece of MAINS/REGULATOR selection switch (pacco switch) which are accessible by the rear side of the regulator.

4.1.2 Startup

1. Turn all switches to the open circuit (OFF) position.
2. Turn the MAINS/REGULATOR selection switch (pacco switch) to “2-REGULATOR” position. The regulator will start in the normal mode automatically. (It will start to operate in 3 phases.)

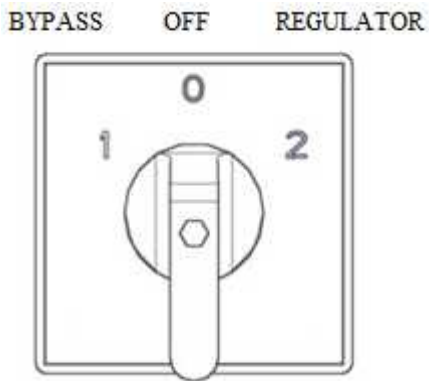

3. Turn the inlet switch to ON position.

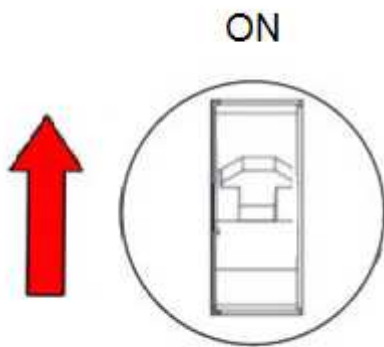

4. Wait for the voltage regulator to start automatically. Control that the device passed to the normal operating mode by the front panel indicator led. The inlet, normal and, outlet led lights must light continuously when the regulator passes to the normal mode.

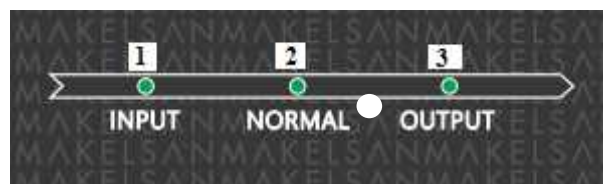

5. You can release the loads connected to the device.

After all of these processes see on the mimic diagram that the loads supplied through the regulator. In any contrary case check the regulator, mains and loads.

4.1.3 Passing to Mechanical Bypass Mode

The mains energy may be transfer to the loads by passing the voltage regulator to mechanical bypass mode when carrying out maintenance or when in the fault condition.

For this; the loads on the outlet of the regulator are deactivated. The inlet switch is turned to OFF position.

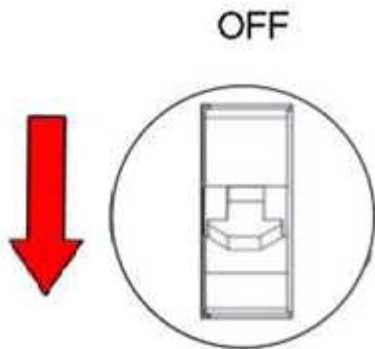

The mains/regulator selection switch is turned to “Bypass” position. The inlet switch is turned to ON position.

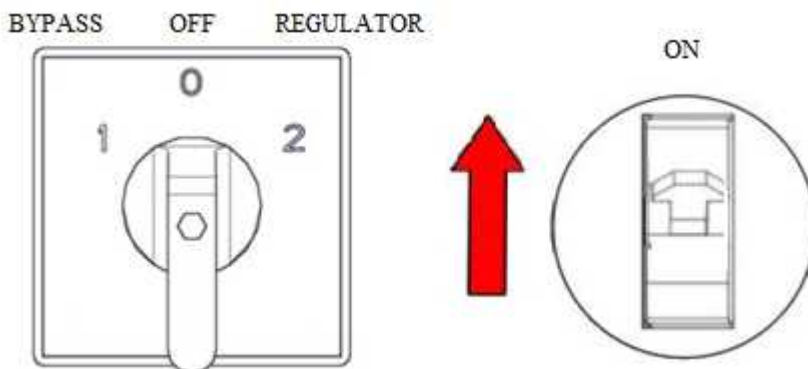

4.1.4 Fully Shutting Down the Regulator

1. Shut down the loads connected to the device.
2. Turn the inlet switch and MAINS/REGULATOR selection switch to “OFF” position, respectively.

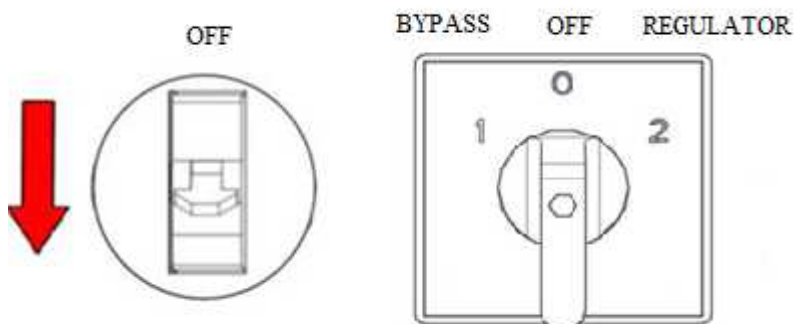



**BE SURE THAT THERE IS NOT CRITICAL LOAD ON THE OUTLET
RIGHT BEFORE SHUTTING DOWN THE DEVICE.**

5 WARNINGS and THEIR EXPLANATIONS

The regulator gives a sound alarm when a trouble is detected. You may have the first information about the situation on mimic diagram. Frequently, this may not be enough. In this case, you may access the warnings below via the Alarm screen.

	WARNING	EXPLANATION OF WARNING
1	Low Input Volt (Low input Voltage)	The mains voltage has decreased under the limits.
2	Low Out Volt (Low Outlet Voltage)	The outlet voltage has decreased under the limits. In this case, the outlet contactor is turned into the OFF position for the protection of the loads on the outlet. The outlet led on front panel turns off.
3	High Out Volt (High Outlet Voltage)	The outlet voltage has risen over the limits. In this case, the outlet contactor is turned into the OFF position for the protection of the loads on the outlet. The outlet led on front panel turns off.
4	Over Load (Over Load)	The outlet loads has risen over the device capacity (>100%). In this case, the outlet loads must be decreased.
5	(Over Temp) Over Temperature Shutting Down	The temperature of the transformer has risen over the limits. The device turns to OFF position. The regulator fan and the ambient temperature must be controlled.

6 TABLE OF TECHNICAL SPECIFICATIONS

) For the models with normal operating range (160-260V);

MODEL	330120	330150
	MRG/MSR	MRG/MSR
DEVICE POWER (kVA)	120	150
INLET		
Inlet Voltage Regulation Range	160 - 250VAC 1phase+N (275-433VAC 1phase+1phase)	
Inlet Frequency and Its Range	50Hz \pm 10%	
Mains Inlet Protection	Over Current, Low Inlet Voltage Warning, Thermal Magnetic Switch	
OUTLET		
Outlet Voltage	220VAC -230VAC adjustable	
Outlet Voltage Tolerance	\pm 1%	
Regulation Rate	90 V/s	
Outlet Frequency	Same as Inlet	
Over Load Capacity	The load situation is controlled in the ranges of 20-10-5 seconds for the loads more than 100% and it is shut down completely if the outlet is still high.	
Outlet Protection	Over Load, Over Temperature, High and Low Voltage Protection	
GENERAL		
Topology	Micro controller controlled, automatic voltage adjustment via variac and dc engine	
Efficiency	>95%	
Indicator	Displaying the inlet voltage-frequency, outlet voltage-current values, load percentage, alarm and warnings via 2x16 LCD Display.	
Operating Temperature	-10°C~40°C	
Storage Temperature	-10°C~+55°C	
Protection Class	IP20	
Color of the Cabin	RAL2000	
Relative Humidity	%0-95	
Operating Altitude	\leq 2500 m from the Sea Level	
Noise Level	<50dB	
Dimensions (WxDxH) (mm)	620x1006x1670 mm	

7 WARRANTY

7.1 Terms of Warranty

- Our products are guaranteed for two years from the delivery date against the malfunctions that may occur because of manufacturing, material and workmanship failures. It will be repaired without demanding workmanship cost and replaced parts cost in these kinds of malfunctions.
- In malfunctions it is specified whether there is a misuse or not via the report issued by service stations; if the service station is not present one of the seller, retail dealer, agencies, representatives, importers or manufacturer-producer of the product, respectively.
- The repair duration of the malfunctioned product is at most twenty workdays. This duration starts at the date of the product has been delivered to one of these; seller, retail dealer, agency, representative, importer and manufacturer of the product. In the case of the product to be failed within the guarantee period, the time spent for repairing is added to the guarantee period. In the case of the repair of the product cannot be completed within ten workdays, the manufacturer-producer or the importer must submit another product having similar specifications to customer until the repair will be completed.
- Although the customer has used his/her repair right, the customer may demand replacement without cost, refund or discount in the ratio of defect, if;
 - the product fails at least four times in a year within the guarantee period or six times within the guarantee period specified by the manufacturer-producer or the importer from the date of the product delivered to the customer, besides these malfunctions cause the customer not to benefit from the product continuously,
 - the maximum time for the repair is exceeded,
 - the repair of the product is not possible according to the report issued by the service station of the company or if the service station is not present one of the following; the seller, retail dealer, agency, representative, importer or manufacturer-producer of the product.
- The customer is liable to declare the guarantee card if requested for the repairs and replacements under warranty.
- You need to do a damage check to the outer package necessarily before receiving the products that have been sent via cargo. In the case of a present damage there must have “damage assessment report” prepared to the delivery person. (Example: The product had been controlled and seen that it was damaged when it delivered to me.)

- Please inform MAKELSAN head office after you have damage assessment report prepared. The product received from cargo against signature means the product has been received without damages and complete.
- For “plug-and-play” products which do not have in-facility maintenance service, the service is made at MAKELSAN plant or at the nearest service point according to the instruction that will be made by MAKELSAN head office. The defective product is delivered to the nearest service point by hand or to the in-network cargo company for sending to MAKELSAN plant in its “original package” according to the instruction that will be made by MAKELSAN head office. For the malfunctions under warranty the cargo fee belongs to MAKELSAN provided that it is delivered to in-network cargo company.
- Unless it is requested by the service, the device should be sent in its original package as boxed. The customer is liable to keep the original package of the device for the purpose of using in the cases of repair that may occur. Otherwise, the responsibility will be refused in difficulties occurred.
- The necessary carriage conditions will be performed by customer for all malfunctioned products sent by hand or via cargo. (Anti-static protector, bubble wrap and box, etc.) A readable barcoded serial number which belongs to product must be present on the product. If not the product is not covered by the guarantee.
- The product which has been sent by cargo must be sent with delivery note, the product’s serial/model/fault information must be written on delivery note (example: malfunction form) and the products specified on the delivery note must match with the package contains. Otherwise, the cargo will not be received.
- In the usage of the certificate of warranty given with MAKELSAN branded products, the parties approve and promise to abide the liabilities specified pursuant to the law on the Protection of the Consumer numbered 6502 and the Certificate of Warranty Regulation issued on the basis of the previous law.

7.2 The Situations not Covered by the Guarantee

- The malfunctions generated from the usage against the rules specified in the operating manual of the product or from the usage out of specified ambient conditions (temperature, humidity, etc.) are not covered by the guarantee.
- The product go beyond the scope of guarantee for the malfunctions arisen from including but not limited to software, hardware, interface, accessories and consumable materials used with the products except recommended ones; transposition, incorrect or insufficient maintenance, calibration or misuse, operating contradictorily to environment specifications issued for product, insufficiency of ventilation system, operating the product in over moist or over temperature ambient, operating in the hazardous and abrasive ambient for electronic circuits; accident, impact, electricity, transportation, natural disasters.

- Some problems that cause the product go beyond the scope of guarantee may not be able to be detected in the general inspection performed at the fault acceptance. The product is returned to the customer in the case of these defects appeared in the detailed post-inspection made by the technical service equipment.
- The products which are out of the scope of guarantee are repaired for a fee via the demand of the customer within the possibilities of the authorized service. The out of guaranteed products of which the repair is not possible are returned to the customer.
- The malfunctions and damages caused by interfering to product, tampering internally or externally, trying to repair and replacing parts without the confirmation of MAKELSAN and, the malfunctions may be caused by interfering an unauthorized service/seller/person/institution go beyond the scope of guarantee. The malfunctions caused by deterioration, breaking down, scratching, aging by time or by usage, corrosion and, dust formation on the outer surfaces of the products (cabin-cover-front panel) are out of the scope of guarantee.
- The product go beyond the scope of guarantee in the cases of the original serial numbers, guarantee labels and seals on the product are removed or destroyed. It is not guaranteed that the product is suitable for using for any other purposes specified in the introduction or operating manual of the products.
- It is mandatory that the purchased product to be engaged in 3 months.

8 CONTACT INFORMATION



www.makelsan.com.tr

İstanbul Plant: İstanbul Deri Organize Sanayi Bölgesi 2. Yol I -5 Parsel 34956 Tuzla/ İstanbul

Tel : 0216 428 65 80

Fax : 0216 327 51 64

E-mail : makelsan@makelsan.com.tr

Ankara Territory: Mustafa Kemal Mah. 2157Sok.No:4/6 Çankaya -Ankara

Tel : 0312 219 82 35/37

Fax : 0312 219 82 36

E-mail : ankara@makelsan.com.tr

İzmir Territory: Halkapınar Mah. 1348 Sok. 2AE Keremoğlu İş Merkezi Yenişehir – İzmir

Tel : 0232 469 47 00

Fax : 0232 449 47 00

E-mail : izmir@makelsan.com.tr

MAKELSAN®

Kesintisiz Güç Kaynakları

www.makelsan.com.tr

İstanbul Plant: İstanbul Deri Organize Sanayi Bölgesi 2. Yol I -5 Parsel 34956 Tuzla/ İstanbul
Tel : 0216 428 65 80
Fax : 0216 327 51 64
E-mail : makelsan@makelsan.com.tr

Ankara Territory: Mustafa Kemal Mah. 2157Sok.No:4/6 Çankaya -Ankara
Tel : 0312 219 82 35/37
Fax : 0312 219 82 36
E-mail : ankara@makelsan.com.tr

İzmir Territory: Halkapınar Mah. 1348 Sok. 2AE Keremoğlu İş Merkezi Yenişehir – İzmir
Tel : 0232 469 47 00
Fax : 0232 449 47 00
E-mail : izmir@makelsan.com.tr